



Eagle Compressors, Inc.

AirQuest SMT™ Trailer Mounted Breathing Air System Key User Features & Benefits

Given the differences in design and scope of supply among the manufacturers of this product class, it is important to recognize that our design, with its standard features, yield user benefits that are un-matched by any competitive product in the market today. The following highlights define key features and resulting benefits that will be of interest to those evaluating proposals for this product:

- Eagle offers a comprehensive and complete standard product proposal. That is, it does not include any main power train, control, instrumentation, air quality monitors or trailer road-ready equipment that is optional. Our standard product includes those features that are generally well understood to be necessary to safely operate a unit of this product class. For example, our standard product includes electronic carbon monoxide (CO) and moisture (H₂O) detectors because it is imperative to automatically monitor air quality when operating a product designed to function at or near the scene of an incident where environmental and human stress factors cannot be totally controlled. Our options are limited to those accessory items that might or might not be essential to a particular user. All optional equipment we offer is clearly described and priced separately.
- Our feature configuration is the AirQuest **SMT™** trailer-mounted breathing air system with a **GenSet** power train design. The GenSet power train design allows the user maximum flexibility as the unit can be run at or near the site of the incident powered by the on-board generator or as an electric driven, stationary system powered by the electric grid of a building. A power “shore” cable is standard equipment and allows the user to connect to power from the Gen-Set or the building’s breaker box. This feature is particularly useful during training or routine filling in that the diesel engine noise and fuel consumption can be eliminated by operating the system as a stationary device powered by electric current from the building it is housed in.
- The most important feature of our GenSet power train design, however, is that it minimizes maintenance and un-expected down time. The diesel engine driven generator is mounted directly on the engine shaft and provides all of the power required to run the electric driven compressor as well as all interior and flood lighting and control requirements. Our GenSet units are rated for a continuous power output ranging from 19 to 28 KW, depending on the compressor size.

This concept is quite different to competitive “dual-drive” designs that use a long, complex and very inefficient power train consisting of an engine, small generator, electric motor and, finally, the compressor driven via v-belts requiring the use of an engine clutch and slap-reducing belt idlers.

This power train design will require constant maintenance, is subject to un-expected down time and has significant mechanical transfer power losses due to its many parts. This inefficient use of power results in high fuel consumption and less air delivery. Our GenSet design includes a large on-board generator that has all the power capacity to run the electric-driven compressor, all interior lights, electrical outlets and flood lights while only using a single belt drive between the electric motor and compressor. It is a simple, efficient, clean and self-contained design with minimal maintenance requirements. **Please refer to the diagrams shown below.**

- The Air Quest **SMT™** is designed to maximize operator safety and comfort. All operating, filling and monitoring controls are conveniently and rationally clustered in the illuminated operating center located at the rear of the trailer. The rear location eliminates driver or curbside operating control decisions and offers the most protection for the operator.
- **The rear door protecting the operating control center during transport is designed to provide the operator protection from the sun, rain and other inclement weather when opened for operations. This feature is not available from any competitive product on the market today.**
- The air system and all operating controls are mounted on a DOT road-ready trailer designed to minimize the power required to tow. The Air Quest SMT™ is designed with an all aluminum trailer frame and body, a feature that limits towing weight, even on our largest air system, to 7800 lbs. The trailer is a heavy-duty, dual axle design with a GVW rating of 10,000 lbs. and, again, it includes standard features that surpass those available in competitive products such as electric brakes, internal 20-gallon diesel fuel tank and dual battery auxiliary power system among others.

EagleAir® Design

The EagleAir® GenSet Design Utilizes One (1) Set of Belts only in the Power Train. This Drive Arrangement Minimizes Moving Parts and the Potential for Un-Expected Breakdowns.

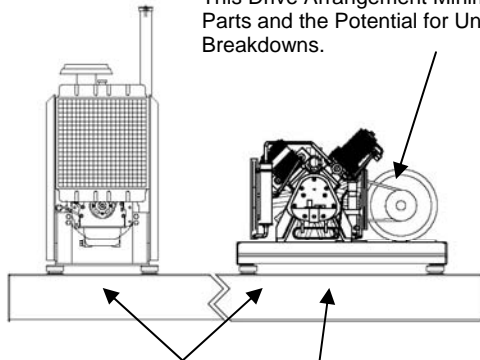

Vibration and Routine Adjustments are Minimized with a Short Power Train Design.

Less Moving Parts also Means Higher Running Efficiency is Obtained from Engine, Generator, and Compressor.

The Result is Consistent Air Delivery from the Compressor at the Rated Output Parameters and Less Overall Energy Consumption.

Competitors' Designs

The Competitors' use a Long Power Train Design that Includes Many Parts, which Results in Significant Mechanical Transfer Losses and Inefficient use of Power to Deliver Air. Power Losses Translate into High Fuel Consumption and Less Air Delivered.

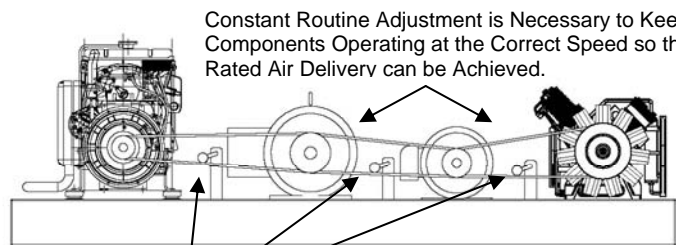

Constant Routine Adjustment is Necessary to Keep all Components Operating at the Correct Speed so that the Rated Air Delivery can be Achieved.

Competitive Designs Rely on Numerous Power Transmission Components, Clutch, Multiple Belt Drives and Necessary Idler Pulleys in Order to Rely on the Output of a Small Generator for Interior and Flood Lights, if Offered.

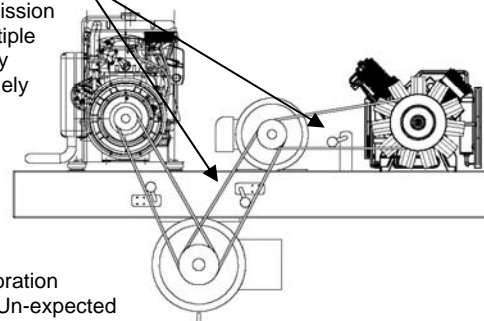

The use of Multiple Running Parts Subjects the Equipment to High Vibration Levels and can Result in Un-expected Breakdowns at Critical Times.



AirQuest SMT Mobile Breathing Air Cylinder Fill System Standard & Optional Features

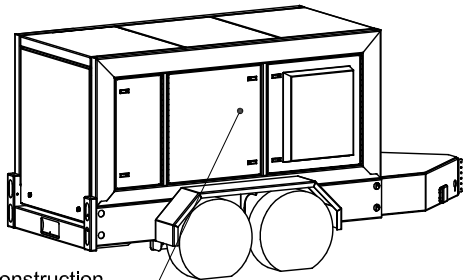

All Aluminum Construction Reduces Towable Weight.

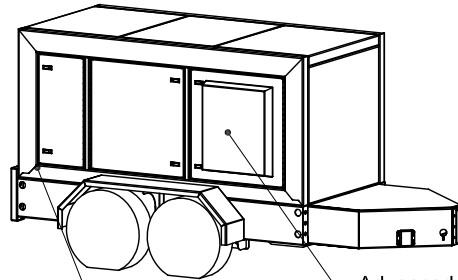

Formed Fabrication Results in Outstanding "Seamless" Finish.

Advanced Fabrication Engineering Assures Assembly Quality and Weather-Tight Fit.

Engineered with Minimum Welding Requirements to Maintain Metal Integrity and Limit Moisture Penetration.

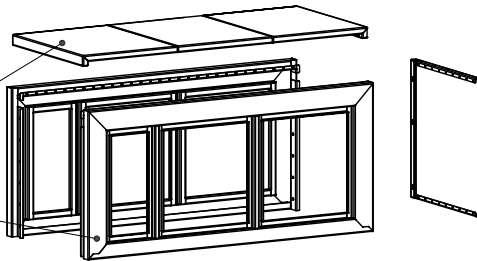

Modular Design Concept Integrates Customer Specific Features From Standard Components.

"Dual Deck" Running Gear Design Minimizes Transfer of Operating Vibration and Provides Generous Access to all Components.

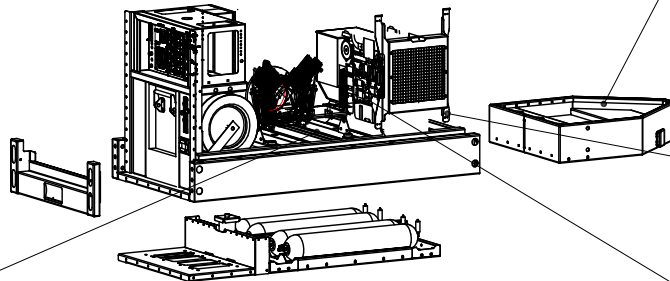

Designed to Accept Various Drive Options and Components.

Illuminated Control Panels Designed For Ease of Use and Can Incorporate any Combination of Variables To Meet Specific Needs.

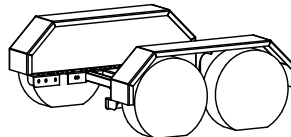

GenSet Design can Provide Breathing Air Support on Site or From a Central Location Wired to a Fixed Power Grid.

Operations Area Design Enhances Simplicity and Safety. Rear Location Protects Operator Even When "CurbSide" Set Up is Not Available.

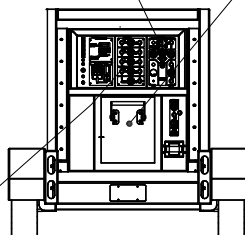

Always Includes 2 or 3 Fill Containment Fill Station With Our "AirLock" Handle Feature For Effortless Operation.

Operator Weather Cover

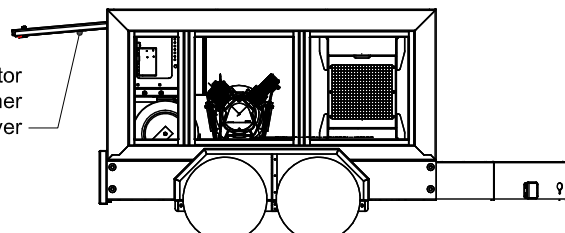

MODEL SHOWN: AQ20G3D5E-GS with MSSx2C4